



Network nodes with gateway

WTX16.GSM
WTX16.IP
WTX16.MOD-1

The WT...16... network nodes are used to receive and handle the data transmitted by consumption meters of the Q AMR system. They are equipped with a gateway that can provide data of up to 2,000 meters for remote readout. WTX16.IP can be read via Ethernet while WTX16.GSM and WTX16.MOD-1 contain a GSM modem. They are read via the telephone network.

Use

The WT...16... network node is a component of the Q AMR system. It has been designed for use in buildings to create a radio network for receiving and storing the data transmitted by the consumption meters installed in the building. Communication between several network nodes is via radio also so that no wiring is required. All measured values acquired by the consumption meters are continuously exchanged within the network, which means that every network node stores the current consumption values, the values read out at the end of the month, and the set day values of all metering devices on the network. Owing to this operating principle, all network data can be read out at any of the nodes, or a QUNDIS gateway for remote data transmission can be used with any of the nodes.

Functions

- Reception and storage of the data transmitted by the consumption meters
- Automatic creation of a network with up to 12 WT...16 (with a maximum of 500 consumption meters)
- Passing on all relevant consumption values to all WT...16 on the network
- Communication via the QUNDIS gateway

Network node versions

The WT...16... network node is a component of the Q AMR system and has been designed for exclusive use with that system.

The network node with integrated gateway is available in a number of versions for different applications:

Type code (ASN)	Application	Integrated M-Bus master	Max. number of meters
WTX16.GSM	Network node with gateway remote readout via GSM	yes, 5 additional unit loads	2000
WTX16.IP	Network node with gateway remote readout via Ethernet	yes, 5 additional unit loads	2000
WTX16.MOD-1	Network node with gateway remote readout via GSM or GPRS*)	no	500**)

*) The use of the GPRS application requires certain provisions by the network operator. To use the GPRS option the user has to conclude a special contract with the service provider.

***) WTX16.MOD-1 has no M-Bus master. It cannot be used to interconnect different networks.

Combinations

All network nodes with gateway can be used in any combination with other QUNDIS network nodes as long as the maximum number of 12 nodes per network is not exceeded.

Network nodes with gateway and integrated M-Bus master (WTX16.GSM and WTX16.IP) can read external M-Bus meters complying EN1434/3.

Basic diagram

**WTX16.GSM
WTX16.IP**

The WT...16... consists of the following blocks:

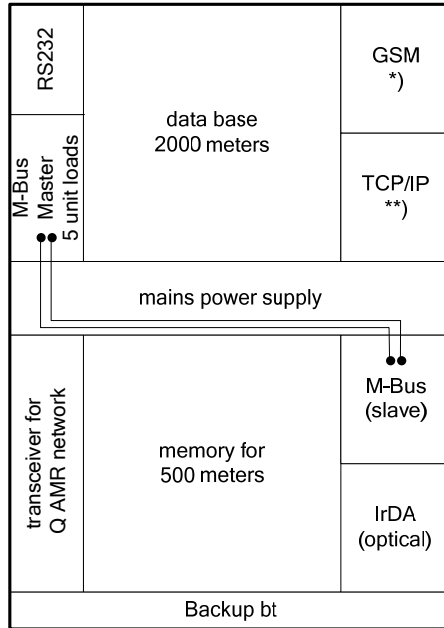

The transmitter and the receiver are used to collect data from the consumption meters and to forward these data to other nodes in the network the data memory stores the consumption data. It is protected against temporary mains power failures by the backup battery. The network nodes WTX16.GSM and WTX16.IP are equipped with a gateway to store data of up to 2000 meters and to provide a possibility for remote readout via GSM or Ethernet. The gateway has an additional M-Bus master that can drive up to 5 additional external M-Bus unit loads (e.g. up to 5 additional M-Bus meters). Usually, however, the M-Bus master is used to connect nodes of different networks to be able to read more meters using only one gateway. For extension of M-Bus, is it possible to connect a repeater to the gateway. The gateway can be programmed using an additional RS232 interface.

*) WTX16.GSM only **) WTX16.IP only

WTX16.MOD-1

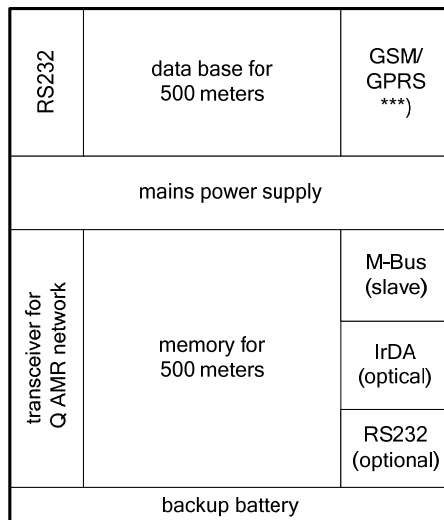

The network node WTX16.MOD-1 is equipped with a gateway for remote readout via GSM or GPRS. It has no M-Bus master, though. Therefore it can read data from one network only (max. 500 meters).

***) user programmable

Basic design

The WT...16... consists of 2 major sections: The base and the housing with the electronics. It is thus possible to mount the base prior to commissioning, enabling the electrical installer to connect the WTX16 to the mains network. At the time of commissioning, the electronics section is snapped on and the electrical connections are made.

Electronics section

The electronics section is identical for all types of network nodes. It contains control elements of the network:

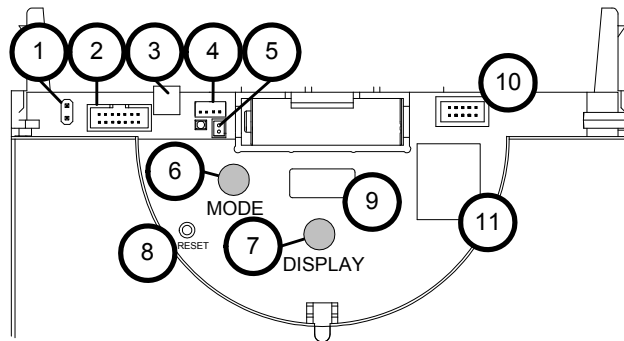

1. Connector for M-bus service connection
2. Connector for RS-232 module
3. Plug terminal for the fixed M-bus connection
4. Connector for power supply DC 3,6 V
5. Connector for backup battery
6. Operating mode button (MODE, red)
7. Button for switching the display (DISPLAY, blue)
8. Reset button (recessed)
9. Display
10. Connector (not for the user)
11. Firmware memory (covered up)

Wall-mounted section
WTX16.GSM/WTX16.IP

The wall-mounted section of WTX16.GSM and WTX16.IP contains these components:

Frontal view

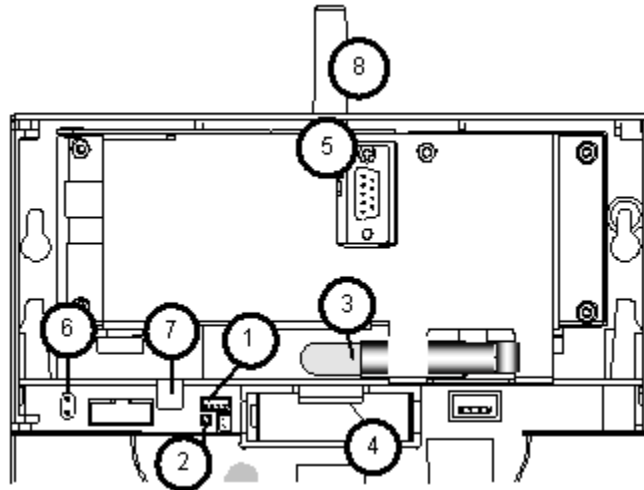

Perspective

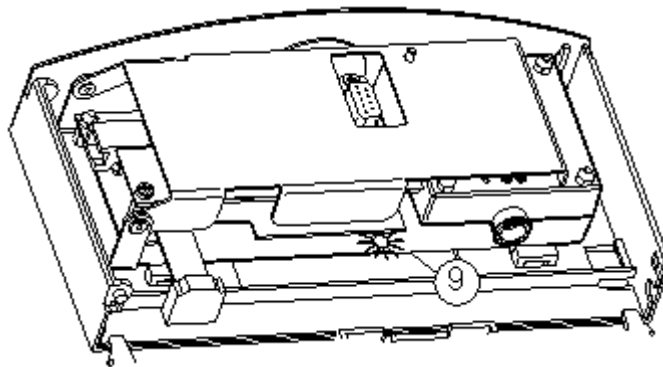

1. Connector for power supply DC 3,6 V
2. Indication of mains supply (red LED)
3. permanently installed cable (no flexible cable!)
4. SIM-card holder (WTX16.GSM only)
5. RS232 interface for servicing
6. Connector for M-bus service connection
7. Screw terminal for the fixed M-bus connection
8. Antenna (WTX16.GSM only)
9. Indication of Gateway status (green LED)

The wall-mounted section of WTX16.MOD-1 contains these components:

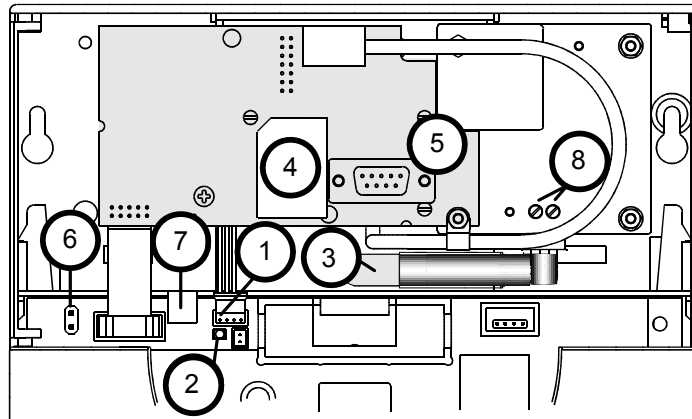







1. Connector for power supply DC 3,6 V
2. Indication of mains supply (red LED)
3. permanently installed cable (no flexible cable!)
4. SIM card holder (WTX16.MOD only)
5. RS232 interface for servicing
6. Connector for M-bus service connection
7. Anschluss für M-Bus
8. mains connection L and N

LED- reaction

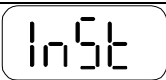
	Blinking interval	meaning
WTX16.GSM/ WTX16.IP	≤ 1sec	Gateway is booting Error
	> 1 sec	Gateway is ready for use
WTX16.MOD-1	≤ 1sec	Gateway is ready for use
	> 1 sec and < 2,5 sec	Error
	≥ 3 sec (only GPRS)	Gateway is ready for use

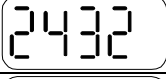

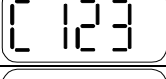

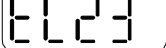

Display

The display of the WT...16... facilitates commissioning work and troubleshooting. In addition to the standard display that shows the operating mode of the WTT16, there are 5 different display levels from "A" to "E" that can be selected by the user.

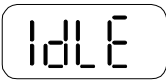
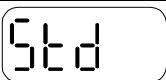
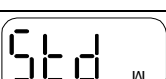
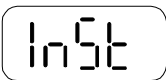









Display level		
-		Current operating mode
A	 	WT...16 number (primary address) and alternate network number
B		Number of WT...16 on the network
C		Number of consumption meters on the network
D		Remaining capacity of the WTT16's main battery in %
E		Error code (3 groups)

Operating modes

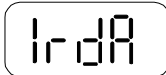
There are different operating modes some of which can be selected by pressing the button on the network node; some are selected automatically, or from a connected PC via the ACT26 commissioning software. The selected operating mode appears on the display:

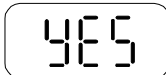
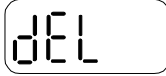
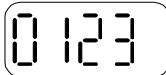
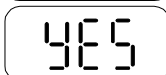
Mode	Display	Explanation
Idle-mode		Delivery status. Switch to install mode by pressing the button MODE (>2 sec).
Standard mode		This is the normal operating mode of the data collectors: Telegrams from the metering devices can be received, stored and handled further by the network.
Extended standardmode ¹⁾		The receiver is always active to ensure fast communication. This mode is automatically activated in the case of mains-powered operation (WTX16...). It can also be started manually with the ACT26 service tool.
Installationsmode ²⁾		In installation mode, the radio network will be built up automatically. Metering devices that transmit installation telegrams in this operating mode will be registered in the network. This mode is started by pressing the MODE button (>2sec).
Extended installationsmode ²⁾		The extended Installation mode will register all metering devices that transmit either installation or data telegrams. This mode is useful if network is expanded later.
Protected installations mode ²⁾³⁾		Same as installation mode, except that connections are built up only by devices with the same network signature.
Search mode		This mode restores radio connection to lost or manually registered metering devices. This mode starts automatically.
Extended search mode ²⁾		This search run is used to restore the radio connection to lost or manually registered metering devices. Starting from version 2.2 this mode can also be started manually by setting jumper 1 (in the plug field) and pressing the MODE button (>2 sec.)
Delete-mode ²⁾³⁾		Same as installation mode, except that all registered metering devices which are transmitting installation telegrams will be deleted. (meter replacement)

- 1) In battery powered network nodes this mode is terminated automatically after eight hours.
- 2) This mode is terminated automatically after eight hours.
- 3) Possibly only with the software ACT26 version 2.0 or higher

State of the system	Display	Explanation
Remote access		During remote access the symbol , 'o' will be displayed.
Highspeed-mode	for example 	When all network nodes have switched on their receivers for fast data exchange, this will be displayed as two dots in the upper part of the LCD.
Bus-connection (from version 2.2)	for example  	If a connection to a bus is being built up, the number of the bus and the primary address of this bus will be briefly displayed . In the example, network node 03 is connected to M-BUS
IrDA-master mode (from version 2.2)		This mode is started by pressing the button MODE. (< 0,5 sec). It indicates readiness to connect additional IrDA devices (in IrDA Slave mode). This mode stops after 10 sec.
Add (from version 2.2)	for example   	If an unregistered IrDA-capable metering device (e.g. WHE467) is connected in IrDA master mode, it can be inserted into the network node by pressing the button DISPLAY while ADD is displayed. The last 4 digits of device number are indicated. (e.g. 20000123). The registration of the device takes place and search mode starts.
Delete (from version 2.2)	for example   	If an already registered IrDA-capable metering device is connected in IrDA-master mode it can be removed from the network node by pressing the button DISPLAY while DEL is displayed. The last 4 digits of device number are indicated (e.g. 20000123). The removal of the device takes place and if necessary search mode is stopped.
Copy (from version 2.2)	for example   	If a new network node (running in idle mode) is connected in IrDA-master mode, it is possible to make a copy of all network data into the new node by pressing the button DISPLAY while COPY is displayed. Copying lasts up to 20 minutes. At the end "StArt Prot" is displayed on LCD of the new network node for 1 hour. After mounting the new node the protected mode is also started by pressing the DISPLAY button. By this procedure the new network node is integrated in network and search mode is started automatically.

Engineering notes

Engineering

For detailed engineering instructions, refer to the QUNDIS Engineering Manual CE1J2870.

Commissioning of WTX..

For mains-powered WTX16.... network nodes, the mains connections are to be made first at the selected mounting positions (typically on every second floor, mounting height ≥ 2 m).

Connection diagram

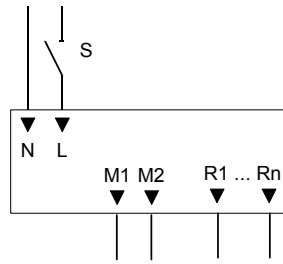

S switch
 L, N AC 230 V mains supply
 M1, M2 M-Bus output
 R1 ... Rn optional interface(s)



CAUTION:
 Connect the mains cable to
 the power supply unit only!

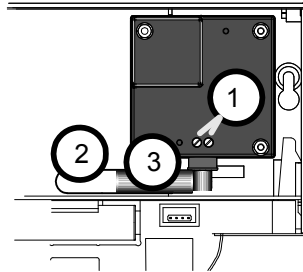

1 Mains connection L and N
 2 Permanently installed mains cable (no flexible
 power cable!)
 3 Extra insulation (shrink sleeve)

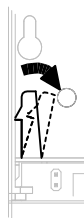

Connect the AC 230 V power supply line to the power pack of the WTX16... in the following order: Remove the upper housing section of the WTX16... from the base. For that purpose, remove the 2 cable connections (power supply (4) and M-Bus (6)) between gateway and base. Then, use a suitable tool (screwdriver or similar) to slightly open one of the two lateral fixing levers so that upper housing section and base can be separated. Then, the top section of the WT...16 is to be fitted using 2 dowels and screws (spacing of dowels is 184 mm with the WTX16...).

Mains connection

Connection of the AC 230 V power line to the power pack of the WTX16... is to be made as follows:

A 2-core mains cable (L and N) has to be preinstalled at the mounting site already. The power pack must be connected by qualified staff. The cores must be sheathed with the enclosed insulating sleeves to ensure compliance with safety class II. Then, the live (L) and neutral (N) conductors must be connected to terminal "IN" of the power pack. Mains voltage must be in the range from AC 100 to 240 V (50 / 60 Hz). There is no protective earth (PE) connection. Then, cable strain relief must be provided by fitting cable ties.

Once the top section of the WTX16 is fitted, the housing with the electronics can be snapped on. Then, the power supply connector can be plugged into the electronics section and the WTT16 switched to installation mode by pressing the MODE button (red) for a few seconds. Then, additional network nodes or consumption meters of the Q AMR system can automatically configure themselves to form a network.

Search run

The standard baud rate of M-Bus master is 2400 Bd. To include 300 Bd M-Bus search it is possible to switch this feature by parameterization software ACT21.

For updating M-bus device directory, there is an automatic search run for new connected devices every 28 days. Devices, disconnected from M-bus, will be automatically deleted from directory after 7 days.

After complete installation of all meters and network nodes, the gateway has to do a search run to find all devices of network(s).

The search run started by triggering a command at the connected PC or by remote using the software ACS26.

Screw tight the GSM antenna prior to commissioning

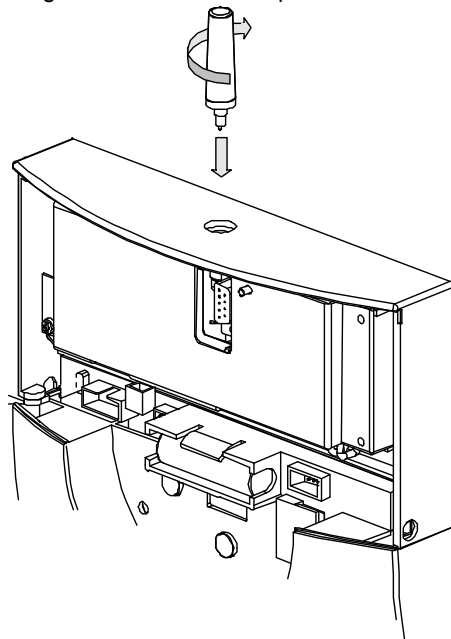

Perspective

SIM card

Network nodes WTX16.GSM and WTX16.MOD-1 require a SIM card and GSM- or GPRS service contracts for voice- and data service. SIM cards, only sold for voice service or M2M service, cannot be used.

WTX16GSM

For that purpose, remove the upper section of the WTX16.GSM from the base. Press the SIM card slightly in the slot at the bottom of the gateway. Ensure that the chamfered corner is in the correct position.

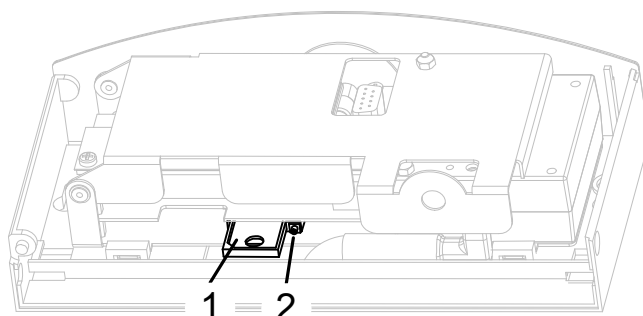

- 1. SIM card
- 2. Card ejector

WTX16.MOD-1

The cardholder is easily accessible

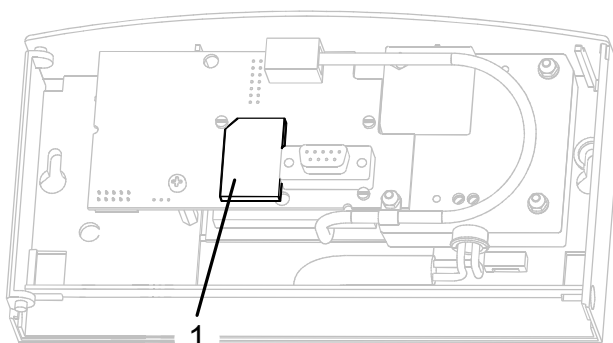

- 1. SIM card holder

Ensure that the chamfered corner of SIM card is in the correct position.

The WTX16.IP network node features an Ethernet interface, which connects to the outside world via an RJ45 connector, where the network cable is to be connected. The distance to the network conduit box may not exceed 2 meters. It is possible, to choose fixed or dynamic (DHCP) IP addresses for WAN communication. The transmission in WAN can be done secured by SSL or unsecured.

Parameter setting

The WTX16.GSM, WTX16.MOD and WTX16.IP network nodes are parameterized with the ACT21 software. The scope of delivery of the software includes an RS-232 cable for connecting the PC to the gateway.

Sealing

On completion of commissioning, secure the network node with the seal provided. Insert the seal in the opening to the right of the network node.

Safety guidelines



After opening the housing, certain parts of the device / system that become accessible carry dangerous voltage. Only qualified staff may interfere with such devices / systems.

- To ensure correct and safe operation, the product must be adequately shipped, stored, installed, operated and maintained.
- Staff dealing with the product must be familiar with all potential hazards and maintenance measures in accordance with the instructions given in this document.
- It must be possible to disconnect the device from the power supply at an easily accessible point (e.g. a switch in the power cable)
- The connection cable has to be protected by an appropriate fuse. Whenever performing any work on the WTX16..., disconnect the device from the mains supply.

Non-observance of these warning notes can lead to personal injury or damage to property!

The local regulations for electrical installations and wireless systems must be complied with.

In Germany:

Pursuant to the "Verordnung über Allgemeine Bedingungen für die Elektrizitätsversorgung von Tarifkunden (AVBEitV)" of the Ministry of Economics, electrical installations behind the house's fused connection may only be erected, extended, changed and maintained by electrical installers that are registered with an electric utility. They must ensure that the general technical regulations and legal safety regulations are complied with.

M-Bus connection

Each network node has a plug terminal for a permanently installed M-Bus connection. A fitting plug is included.

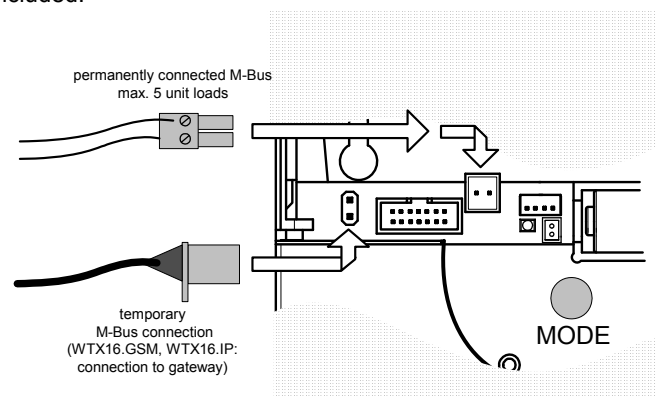

Technical data

CE conformity to EMC directives

Protection degree	IP 32 (WTX16.IP has IP21)	
Safety class	2	
Electromagnetic compatibility	Immunity:	EN 55 024/EN 301 489
	Emissions:	EN 55 022/EN 300 220-1
Operating voltage WTX16...	AC 100..240 V 50/60 Hz	
Rated frequency	868,3 MHz	
Transmitter power	< 14 dBm	
Frequency of transmission	<1 %	
Permanent ambient temperature		
	Transport and storage	-20...+60 °C (< 30 °C recommended)
	Operation	0...55 °C
Weight	0,3 kg	

Dimensions

WTX16...

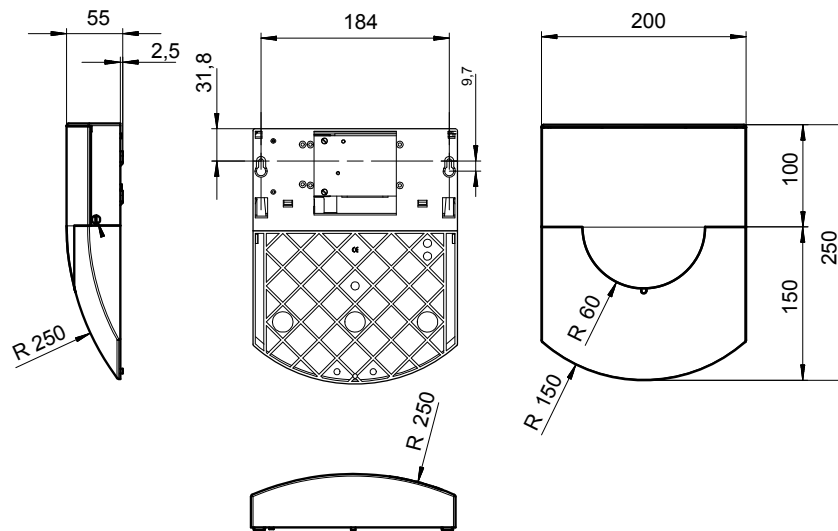

The information provided in this Data Sheet only gives general descriptions and general technical features which, in the case of specific applications, may not necessarily apply, or which may change due to further development of the product. Technical features are binding only when expressly agreed upon at the time a contract is concluded.

©2009 QUNDIS GmbH
Subject to alteration